

High-speed wrapping machine for preformed products in double twist.
The continuous motion principle of the machine enables efficient and reliable high-performance wrapping of mass production.

EK3

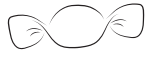

Double Twist
Protected Twist



Products

- products suitable for plate feeding
- Hard Candy
(with or without center-filling)
- Eclair
- Toffees

Output

- up to 1800 products/min

Product dimensions

	Length: 16–40 mm Width: 12–25 mm Height: 6–20 mm
	Ø: 13–28 mm (special design up to diameter: 33 mm) Height: 6–20 mm
	Ø: 17–23 mm

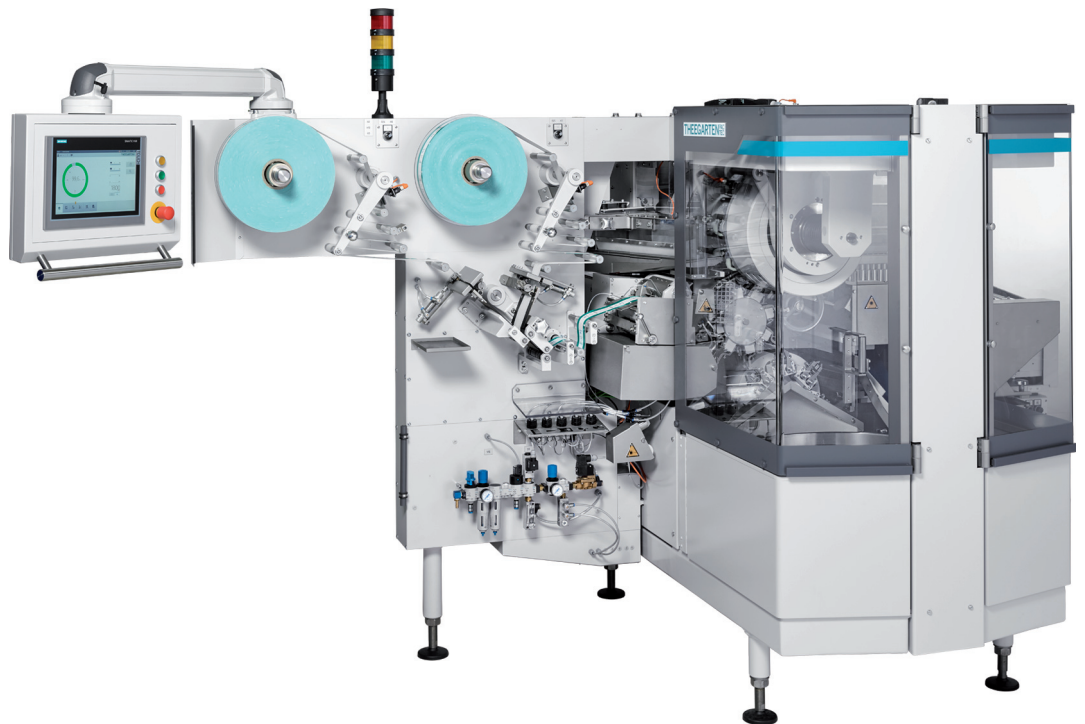

EK3

Wrapping material

- Wax paper
- Cellophane
- Polypropylene
- Polyethylene

Material dimensions

- Reel diameter: up to 350 mm
- Reel width: up to 120 mm
- Core diameter: 70–76,2 mm

Utilities

- Connected load: 13 kVA
- Compressed air consumption: 2m³/h; 600 kPa

Measurements

- Machine:
 - Length: 3080 mm
 - Width: 2730 mm
 - Height: 1880 mm
- Switch cabinet:
 - Length: 1200 mm
 - Width: 500 mm
 - Height: 1960 mm

Weight

- Machine:
 - 2250 kg without inner wrapper
 - 2550 kg with inner wrapper
- Switch cabinet: 350 kg

Combination

Beside manual feeding, the machine can be directly synchronized to the production line by means of a Theegarten-Pactec feeding system.

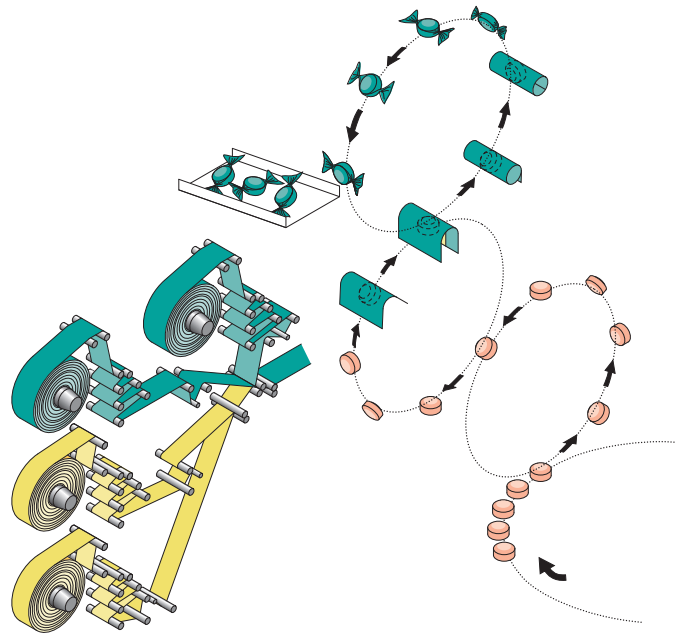

Special features

- A particularly gentle handling of the products is guaranteed by the continuous motion principle
- highly efficient feeding system with integrated sorting station to eliminate sugar dust, chips and broken pieces
- Servo control with PLC functions
- Air support to allow the use of PP foils
- Saving of wrapping material by “no product – no paper” -device
- Automatic splicer to change wrapping material reels without stopping the machine
- Ejection of spliced, mal-registered and unwrapped products
- Infinitely variable adjustment of the twist gripper oscillation depending on the wrapping material quality
- Adjustment of the twisting angle in three steps (1,1; 1,6; 2,1 rotations)
- Different executions of the twist grippers for different wrapping materials
- Servo-driven wrapping material feed rollers and wrapping material knife
- Pneumatic core locking and reel tensioning devices

- All electrical and electronic components are located in a separate switch cabinet
- Excellent accessibility for operation, maintenance and cleaning purposes
- Easy operation due to the touch screen
- Due to the automatic operation, several machines can be handled by one operator
- System of protection: IP 54

Options

- Photo-electric print registration
- Additional reel holders for a second wrapping material (under strip) with automatic splicer
- Special execution for moulded toffees
- remote diagnostics
- Optional device for hermetically sealed, airtight packages (“Protected Twist”)